

### Parts

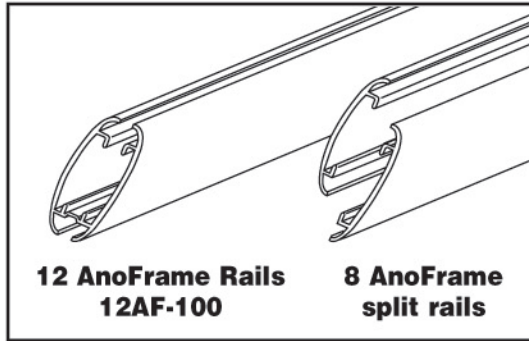
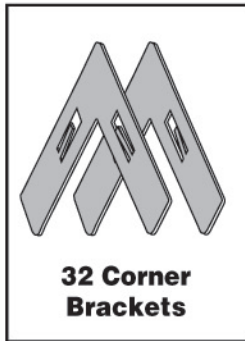

### Instructions for assembly

**Note:** You will be assembling four frames. Below instructions are for one frame only. Repeat steps 1 & 2 for each frame.

#### Step 1

Locate two split rails and a solid rail that is the same length as the split rails.

Insert two corner brackets in each end of the solid side AnoFrame rail. Insert one corner bracket into each end of each split side AnoFrame rails. **Fig. 1.**

**Note:** Tension tabs on corner brackets face towards outside of frame rails.

#### Step 2

Assemble frame following steps in **Fig. 2** sliding sides together in the order shown.

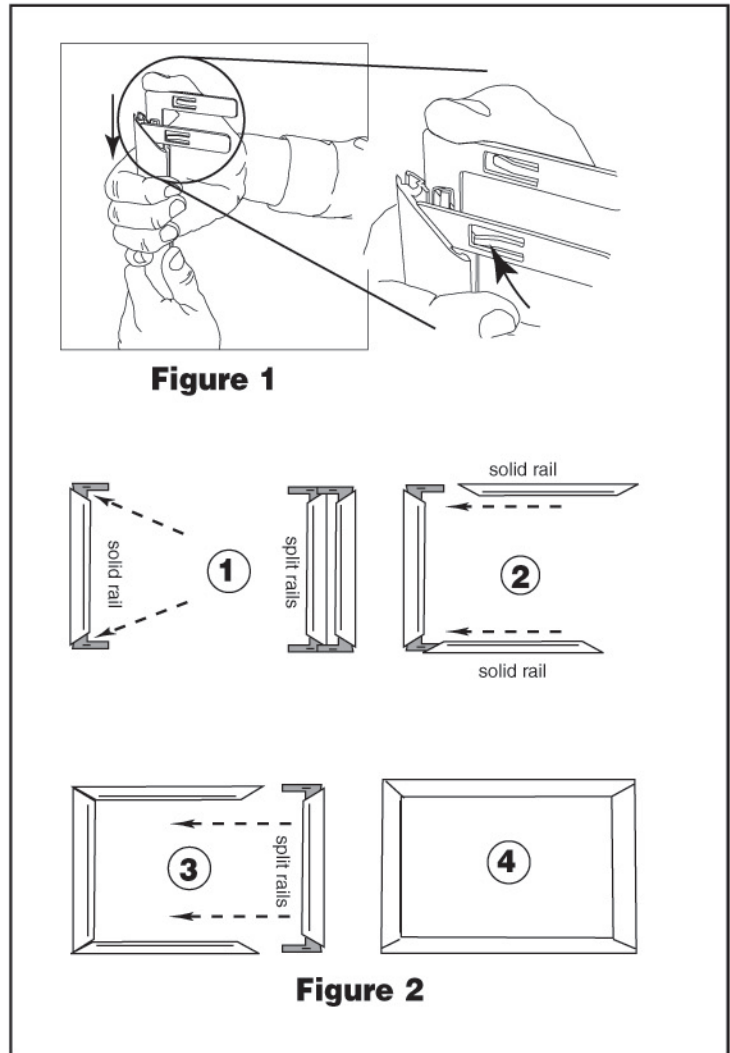

# Side-Loading AnoSkyBox™

## Instruction Sheet

### Parts

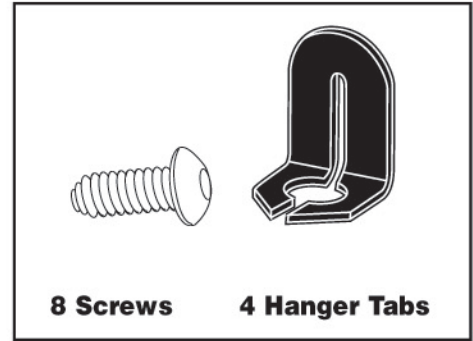
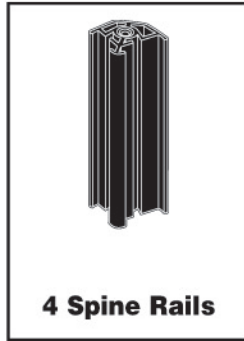
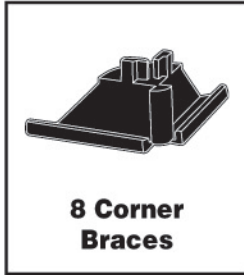

### Instructions for assembly

#### Step 3

Attach one corner brace onto one end of each corner spine. Fig. 3.

#### Step 4

Screw into place and tighten. Fig. 4.

#### Step 5

Lay out AnoSkyBox parts as shown. Be sure to lay out frames so each corner contains matching frame sides — two corners should contain only split rails and two corners should contain only solid rails. Fig. 5.

**Note:** Once side of each frame contains split rails. When laying out your AnoSkybox, make sure you match the split rail sides of both frames to the same corner spine. You should have only 2 corners containing split rails.

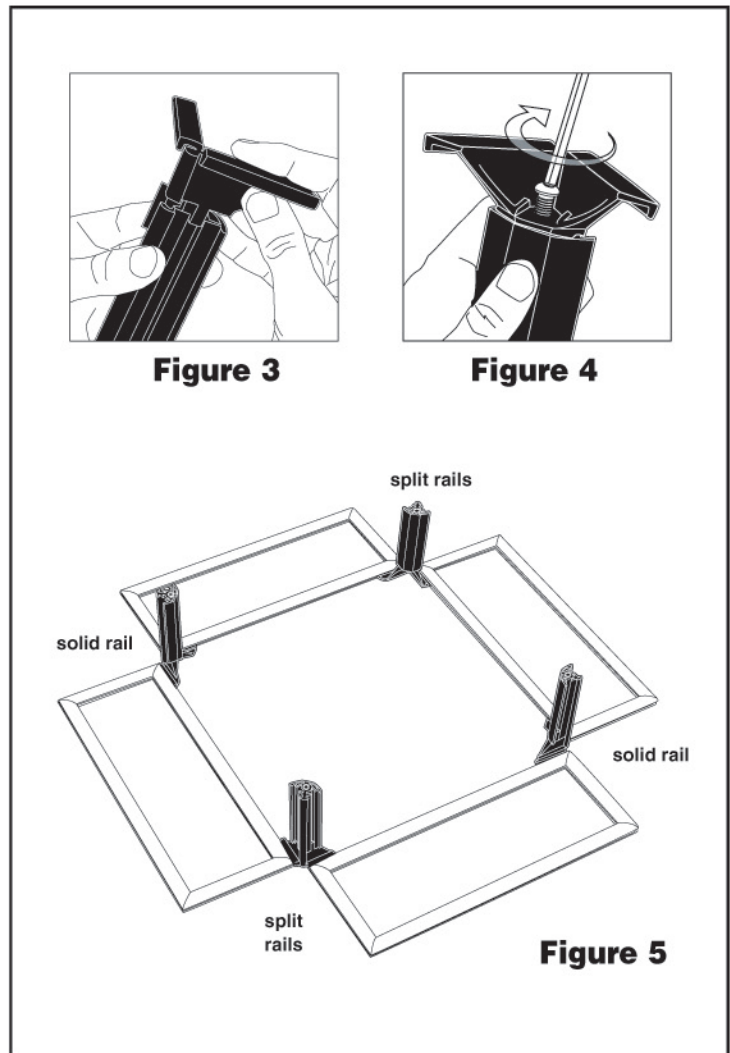

### Parts

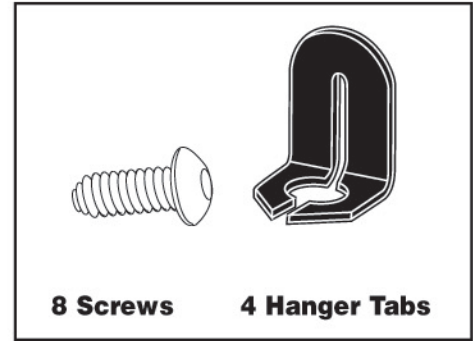
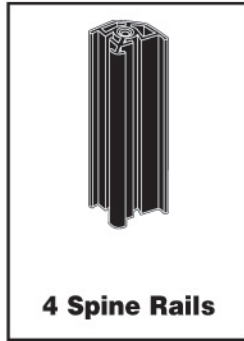
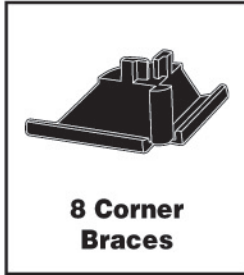

### Instructions for assembly

#### Step 6

Attach frames to corner spines. Be sure to insert bottom rib of corner brace into bottom channel of the AnoFrame rail, as shown in Fig. 6.

Repeat for all frames. Fig. 7.

#### Step 7

Attach one corner brace onto the top of each corner spine rail. Fig. 8.

#### Step 8

If using the cable and loop for hanging, insert loop into hanger tab. If using the cable and saucer for hanging, insert saucer into hanger tab. Fig. 9.

#### Step 9

Insert one screw into each hanger tab and align with hole in top corner brace. Fig. 10.

#### Step 10

Screw hanger tab into place. Fig. 11.

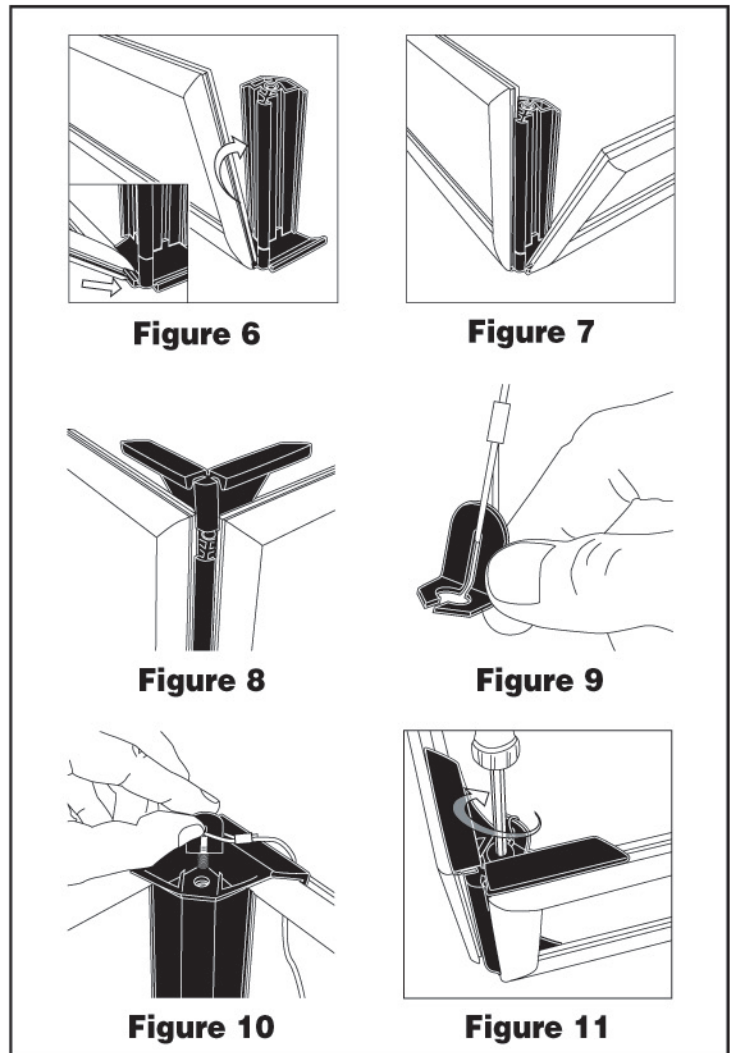

### Parts

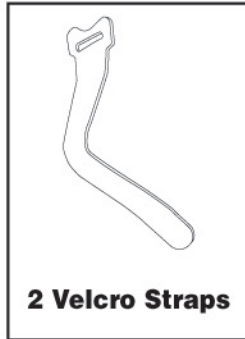

### Instructions for assembly

#### Step 11

Insert one Velcro strap through each corner containing split rails. Slide the strap through the split rails. Fig. 12.

#### Step 12

Tighten and secure in place on the inside of the AnoSkyBox. Fig. 13.

#### Step 13

Suspend AnoSkyBox through hanger tabs with appropriate Rose Displays hanging accessories.

#### Step 14

Insert graphics. Fig. 14.

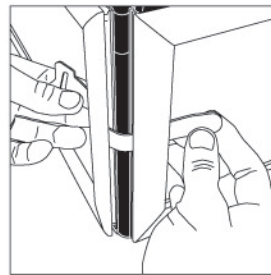

Figure 12

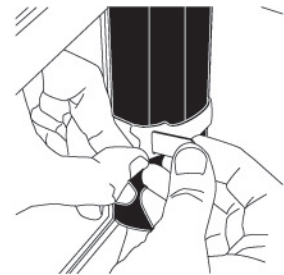

Figure 13

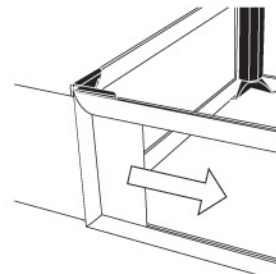

Figure 14