

Parts

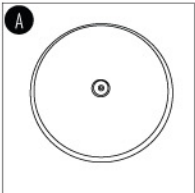

Base

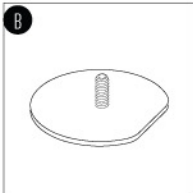

Base Connector

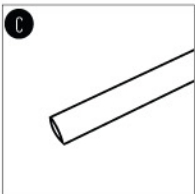

Pole

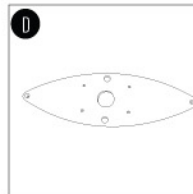

Bottom Shelf

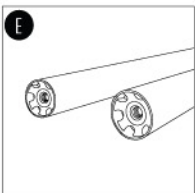

Side Poles

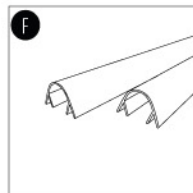

Side Rails

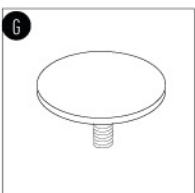

Top Shelf Connector

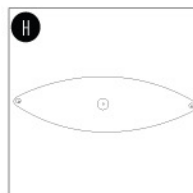

Top Shelf

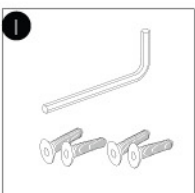

Hex Screwdriver and 4 screws

Note: Please layout parts in order on the floor before assembly.

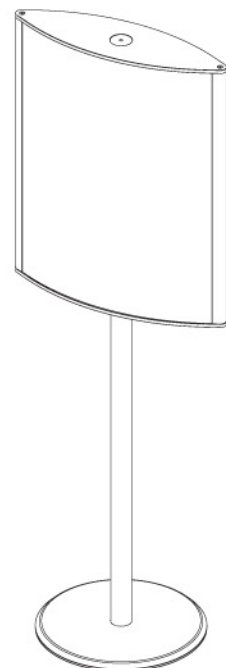
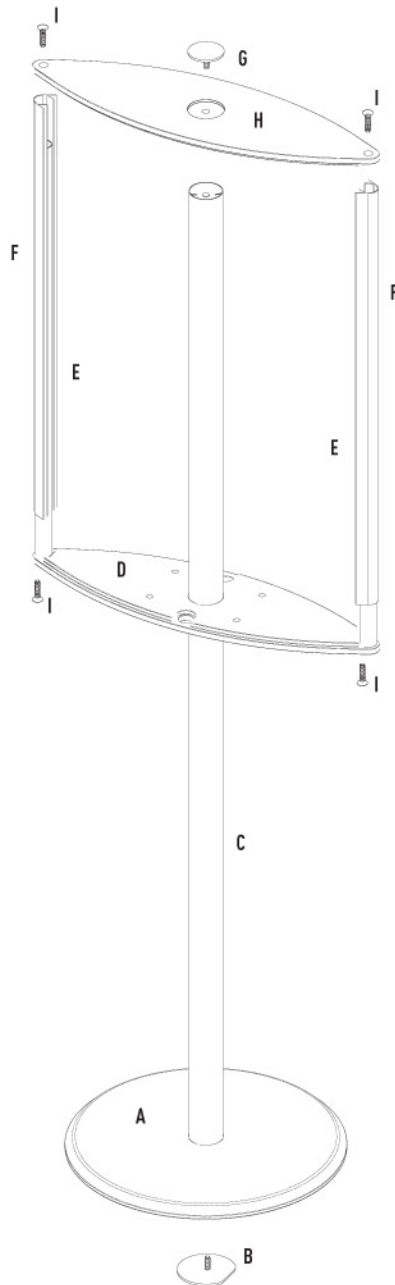

Final Look

